







Hbbi(II)ns, Hbbi(II)ns(s)



UIC	TWA	Dispo-Gruppe
Hbbi(II)ns	AHN 1	ZD
Hbbi(II)ns(s)	AHN 2	ZD

Hbbi(II)ns, Hbbi(II)ns(s)

 Wagentdaten	 Wagon data	 Caractéristiques techniques	 Caratteristiche tecniche	 Vagndata	 Dane wagonu	 Vagon detayları	AHN 1	AHN 2
Dispo-Gruppe	Order group	Code groupe	Gruppo Dispo	Dispogrupp	Typ wagonu	Vagon Grubu	ZD	ZD
Profil	Gauge	Gabarit	Profilo	Profil	Profil	Gabari	G 1	G 1
Wagenlänge über Puffer	Overall length over buffers	Longueur hors tout	Lunghezza carro tra i respingenti	Längd över buffertar	Długość wagonu ze zderzakami	Tamponlar arası uzunluğu	15.500 mm	15.500 mm
Ladelänge	Loading length	Longueur utile	Lunghezza del piano di carico	Lastytans längd	Długość przestrzeni ładunkowej	Yükleme Boyu	14.236 mm	14.236 mm
Ladebreite	Loading width	Largueur utile	Larghezza del piano di carico	Lastytans bredd	Szerokość przestrzeni ładunkowej	Yükleme Eni	2.950 mm	2.950 mm
Ladefläche	Loading area	Superficie utile	Superficie di carico	Lastyta	Powierzchnia ładunkowa	Yükleme Alanı	42 m²	42 m²
Laderaum	Loading volume (cube)	Volume utile	Volume di carico	Lastvolym	Pojemność ładunkowa	Yükleme Hacmi	116 m³	115 m³
Schiebewandöffnung - Höhe	Access height when sliding doors fully opened/retracted	Ouverture des portes (hauteur)	Apertura parete scorrevole - Lunghezza	Skjuddörröppning - höjd	Wysokość otworu po otwarciu drzwi przesuwanych	Kapı Ölçüleri - Yüksekliği	2.850 mm	2.900 mm
Schiebewandöffnung - Breite	Access width when sliding doors fully opened/retracted	Ouverture des portes (largeur)	Apertura parete scorrevole - Larghezza	Skjuddörröppning - bredd	Szerokość otworu po otwarciu drzwi przesuwanych	Kapı Ölçüleri - Eni	6.995 mm	6.933 mm
Fußbodenhöhe über Schienenoberkante	Height of wagon floor over rail	Hauteur du plancher au-dessus du rail	Altezza del piano di carico dal piano rotaia	Lastytans höjd över rälsöverkant	Wysokość podłogi nad główką szyny	Platformun Raydan Yüksekliği	1.205 mm	1.190 mm
Zulässige Fußbodenbelastung	Maximum floor pressure allowed	Limite de charge du plancher	Limite di portata del pavimento	Högsta tillåtna golbelastning	Dopuszczalna obciążenie podłogi	Maksimum Taban taşıma kapasitesi	30 kN	50 kN
Eigengewicht	Tare weight	Tare	Tara	Egenvikt	Masa własna	Darası	ca. 15.000 kg	ca. 15.000 kg
Lastgrenze D	Payload D	Limite de charge sur ligne D	Limite di portata (Linee classe D)	Lastgräns D	Dopuszczalna masa brutto (klasa D)	Yükleme Sınırları (D Hatları)	ca. 30,0 t	ca. 30,0 t
Lastgrenze C	Payload C	Limite de charge sur ligne C	Limite di portata (Linee classe C)	Lastgräns C	Dopuszczalna masa brutto (klasa C)	Yükleme Sınırları (C Hatları)	ca. 26,0 t	ca. 26,0 t
Kleinster befahrbarer Gleisbogenhalbmesser	Minimum curve radius	Rayon minimum de passage en courbe	Raggio minimo di curvatura	Minsta kurvradie	Minimalny promień skrętu	En az Kurp Yarıçapı	75 m	75 m
Palettenkapazität - Euro-Paletten	Pallet capacity - Euro Pallets	Nombre de palettes européennes	Capacità di carico - Euro-palette	Pallkapacitet - Eur-Pallar	Ilość palet - europalety	Palet Kapasitesi (Adet) EUR	40 units	40 units
Palettenkapazität - Industriepaletten	Pallet capacity - Industrial Pallets	Nombre de palettes industrielles	Capacità di carico - Palette industriali	Pallkapacitet - industriepallar	Ilość palet - palety przemysłowe	Palet Kapasitesi (Adet) EUR3 ve Universal	28 units	28 units

Hbbi(II)ns, Hbbi(II)ns(s)

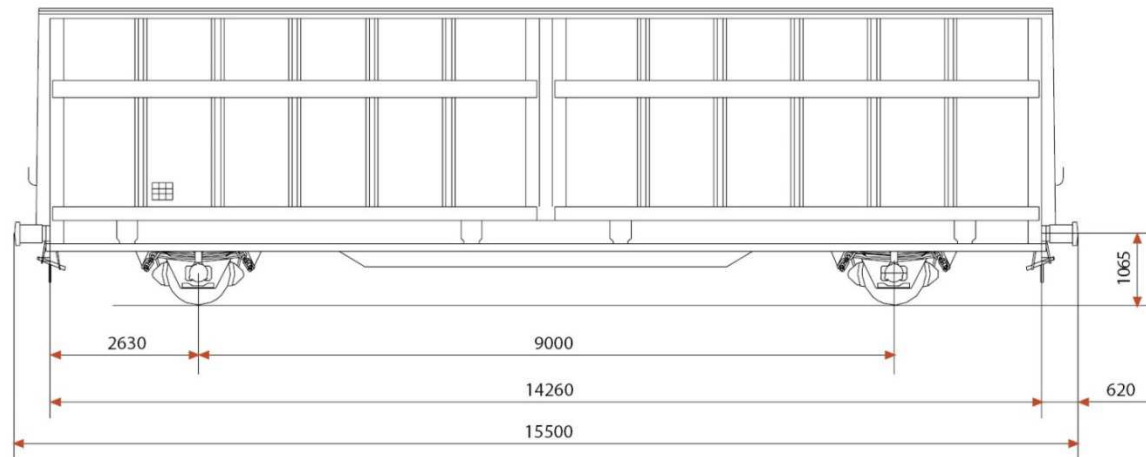

AHN 1 / AHN 2

	A	B	C	D	
S	17,0 t	21,0 t	26,0 t	30,0 t	**
SS	17,0 t	21,0 t	25,0 t		

Palettenstellplätze

40 EUR-Paletten (800 x 1200)



28 IND-Paletten (1000 x 1200)



Hbbi(II)ns (AHN1)

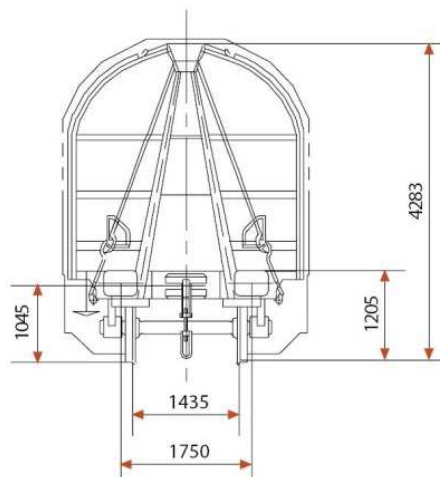
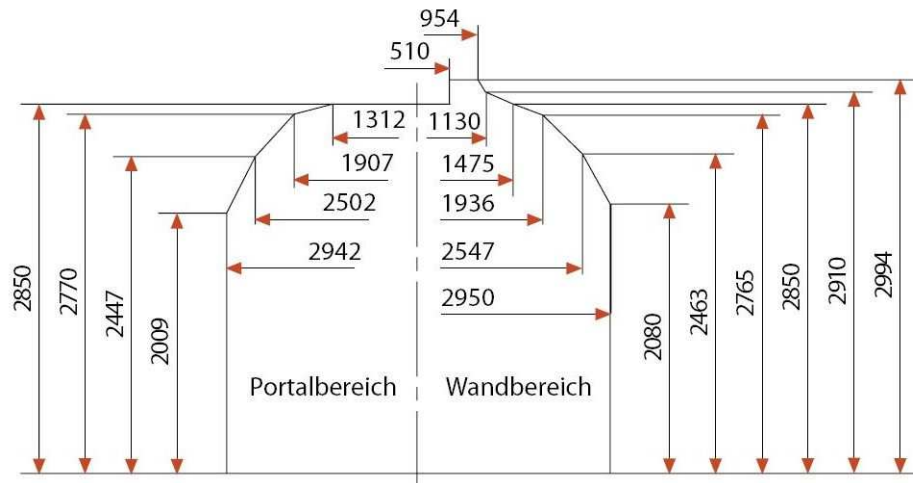

Höhe über Fußboden	AHN 1	
	Vorhandene Ladebreite im Wandbereich	Säulenbereich
2009	2950	2942
2080	2950	2871
2100	2929	2851
2150	2876	2800
2200	2824	2750
2250	2771	2700
2300	2719	2650
2350	2666	2599
2400	2613	2549
2447	2564	2502
2463	2547	2473
2500	2472	2404
2550	2371	2312
2600	2270	2220
2650	2169	2128
2700	2068	2036
2765	1936	1916
2770	1909	1907
2800	1746	1684
2850	1475	1312

Hbbi(II)ns(s) (AHN2)

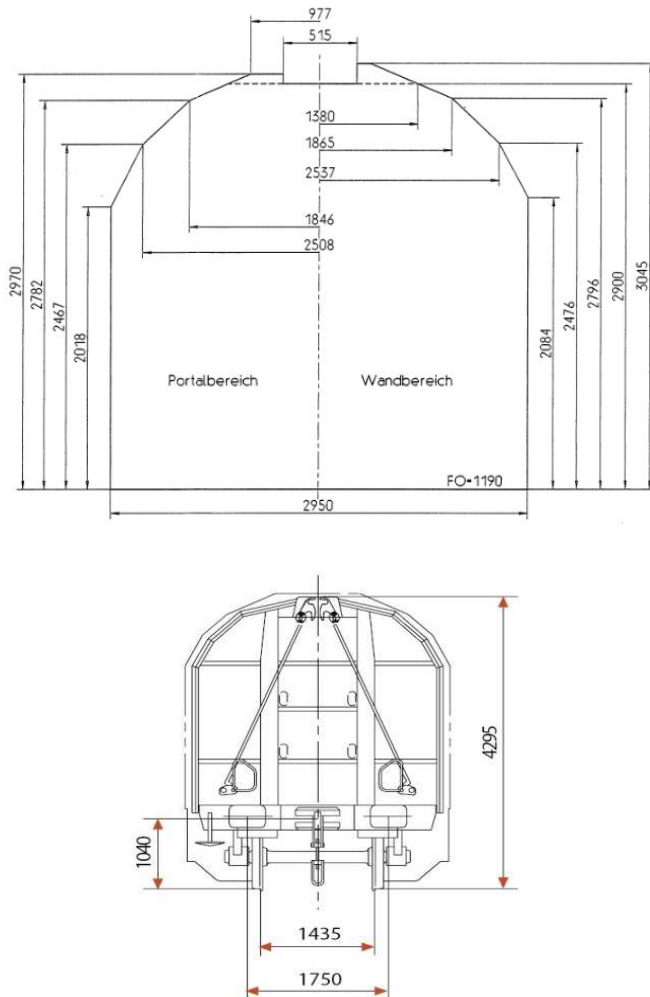

Höhe über Fußboden	AHN 2	
	Vorhandene Ladebreite im Wandbereich	Säulenbereich
2018	2950	2950
2084	2950	2885
2150	2880	2820
2200	2828	2771
2250	2775	2722
2300	2722	2672
2350	2670	2623
2400	2617	2574
2467	2546	2508
2476	2537	2489
2500	2487	2439
2550	2382	2334
2600	2277	2228
2650	2172	2123
2700	2067	2018
2750	1962	1913
2782	1894	1846
2796	1865	1781
2850	1613	1532
2900	1380	1301